

**Applications**

- High Frequency DC-DC Isolated Converters with Synchronous Rectification for Telecom and Industrial Use
- High Frequency Buck Converters for Computer Processor Power

HEXFET® Power MOSFET

<b>V<sub>DSS</sub></b>	<b>R<sub>DS(on)</sub> max</b>	<b>I<sub>D</sub></b>
<b>30V</b>	<b>12mΩ</b>	<b>62A</b>

**Benefits**

- Ultra-Low Gate Impedance
- Very Low R<sub>DS(on)</sub> at 4.5V V<sub>GS</sub>
- Fully Characterized Avalanche Voltage and Current

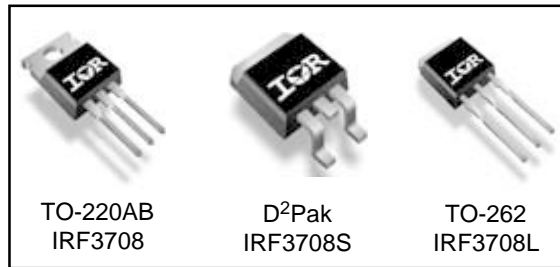

**Absolute Maximum Ratings**

Symbol	Parameter	Max.	Units
V <sub>DS</sub>	Drain-Source Voltage	30	V
V <sub>GS</sub>	Gate-to-Source Voltage	±12	V
I <sub>D</sub> @ T <sub>C</sub> = 25°C	Continuous Drain Current, V <sub>GS</sub> @ 10V	62	A
I <sub>D</sub> @ T <sub>C</sub> = 70°C	Continuous Drain Current, V <sub>GS</sub> @ 10V	52	
I <sub>DM</sub>	Pulsed Drain Current <sup>①</sup>	248	
P <sub>D</sub> @ T <sub>C</sub> = 25°C	Maximum Power Dissipation <sup>③</sup>	87	W
P <sub>D</sub> @ T <sub>C</sub> = 70°C	Maximum Power Dissipation <sup>③</sup>	61	W
	Linear Derating Factor	0.58	W/°C
T <sub>J</sub> , T <sub>STG</sub>	Junction and Storage Temperature Range	-55 to + 175	°C

**Thermal Resistance**

	Parameter	Typ.	Max.	Units
R <sub>θJC</sub>	Junction-to-Case	—	1.73	°C/W
R <sub>θCS</sub>	Case-to-Sink, Flat, Greased Surface <sup>④</sup>	0.50	—	
R <sub>θJA</sub>	Junction-to-Ambient <sup>④</sup>	—	62	
R <sub>θJA</sub>	Junction-to-Ambient (PCB mount)*	—	40	

\* When mounted on 1" square PCB (FR-4 or G-10 Material) .  
 For recommended footprint and soldering techniques refer to application note #AN-994

Notes ① through ④ are on page 10

# IRF3708/3708S/3708L

International  
IR Rectifier

## Static @ $T_J = 25^\circ\text{C}$ (unless otherwise specified)

	Parameter	Min.	Typ.	Max.	Units	Conditions
$V_{(BR)DSS}$	Drain-to-Source Breakdown Voltage	30	—	—	V	$V_{GS} = 0V, I_D = 250\mu A$
$\Delta V_{(BR)DSS}/\Delta T_J$	Breakdown Voltage Temp. Coefficient	—	0.028	—	V/ $^\circ\text{C}$	Reference to $25^\circ\text{C}, I_D = 1\text{mA}$
$R_{DS(on)}$	Static Drain-to-Source On-Resistance	—	8	12.0	m $\Omega$	$V_{GS} = 10V, I_D = 15A$ ③
		—	9.5	13.5		$V_{GS} = 4.5V, I_D = 12A$ ③
		—	14.5	29		$V_{GS} = 2.8V, I_D = 7.5A$ ③
$V_{GS(th)}$	Gate Threshold Voltage	0.6	—	2.0	V	$V_{DS} = V_{GS}, I_D = 250\mu A$
$I_{DSS}$	Drain-to-Source Leakage Current	—	—	20	$\mu A$	$V_{DS} = 24V, V_{GS} = 0V$
		—	—	100		$V_{DS} = 24V, V_{GS} = 0V, T_J = 125^\circ\text{C}$
$I_{GSS}$	Gate-to-Source Forward Leakage	—	—	200	nA	$V_{GS} = 12V$
	Gate-to-Source Reverse Leakage	—	—	-200		$V_{GS} = -12V$

## Dynamic @ $T_J = 25^\circ\text{C}$ (unless otherwise specified)

Symbol	Parameter	Min.	Typ.	Max.	Units	Conditions
$g_{fs}$	Forward Transconductance	49	—	—	S	$V_{DS} = 15V, I_D = 50A$
$Q_g$	Total Gate Charge	—	24	—	nC	$I_D = 24.8A$ $V_{DS} = 15V$ $V_{GS} = 4.5V$ ③
$Q_{gs}$	Gate-to-Source Charge	—	6.7	—		
$Q_{gd}$	Gate-to-Drain ("Miller") Charge	—	5.8	—		
$Q_{oss}$	Output Gate Charge	—	14	21		
$t_{d(on)}$	Turn-On Delay Time	—	7.2	—		
$t_r$	Rise Time	—	50	—	ns	$V_{DD} = 15V$ $I_D = 24.8A$ $R_G = 0.6\Omega$ $V_{GS} = 4.5V$ ③
$t_{d(off)}$	Turn-Off Delay Time	—	17.6	—		
$t_f$	Fall Time	—	3.7	—		
$C_{iss}$	Input Capacitance	—	2417	—	pF	$V_{GS} = 0V$ $V_{DS} = 15V$ $f = 1.0\text{MHz}$
$C_{oss}$	Output Capacitance	—	707	—		
$C_{rss}$	Reverse Transfer Capacitance	—	52	—		

## Avalanche Characteristics

Symbol	Parameter	Typ.	Max.	Units
$E_{AS}$	Single Pulse Avalanche Energy②	—	213	mJ
$I_{AR}$	Avalanche Current①	—	62	A

## Diode Characteristics

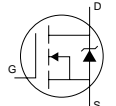
Symbol	Parameter	Min.	Typ.	Max.	Units	Conditions
$I_S$	Continuous Source Current (Body Diode)	—	—	62	A	MOSFET symbol showing the integral reverse p-n junction diode. 
$I_{SM}$	Pulsed Source Current (Body Diode) ①	—	—	248		
$V_{SD}$	Diode Forward Voltage	—	0.88	1.3	V	$T_J = 25^\circ\text{C}, I_S = 31A, V_{GS} = 0V$ ③
		—	0.80	—		$T_J = 125^\circ\text{C}, I_S = 31A, V_{GS} = 0V$ ③
$t_{rr}$	Reverse Recovery Time	—	41	62	ns	$T_J = 25^\circ\text{C}, I_F = 31A, V_R = 20V$
$Q_{rr}$	Reverse Recovery Charge	—	64	96	nC	$di/dt = 100A/\mu s$ ③
$t_{rr}$	Reverse Recovery Time	—	43	65	ns	$T_J = 125^\circ\text{C}, I_F = 31A, V_R = 20V$
$Q_{rr}$	Reverse Recovery Charge	—	70	105	nC	$di/dt = 100A/\mu s$ ③

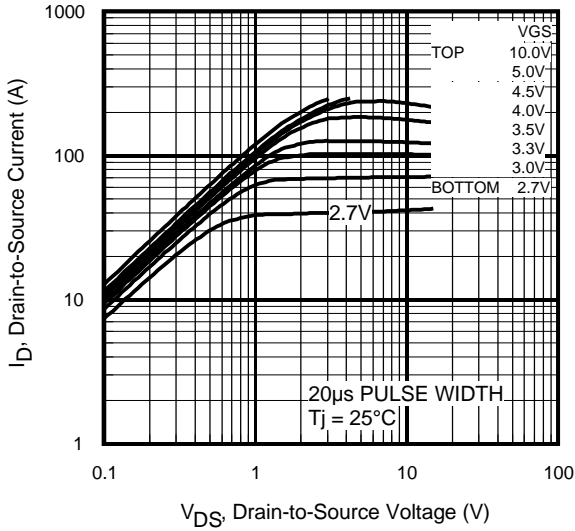

**Fig 1.** Typical Output Characteristics

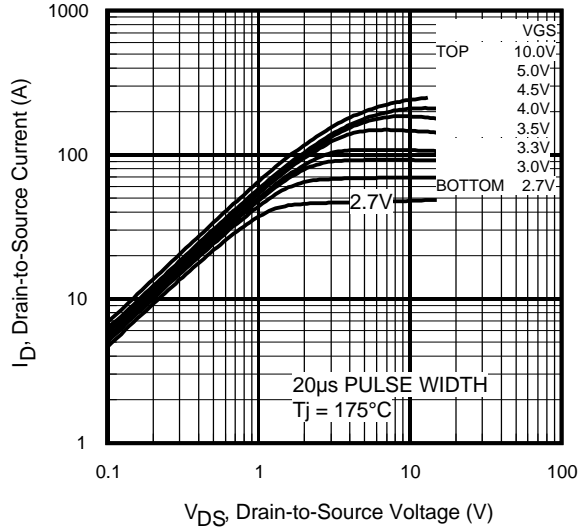

**Fig 2.** Typical Output Characteristics

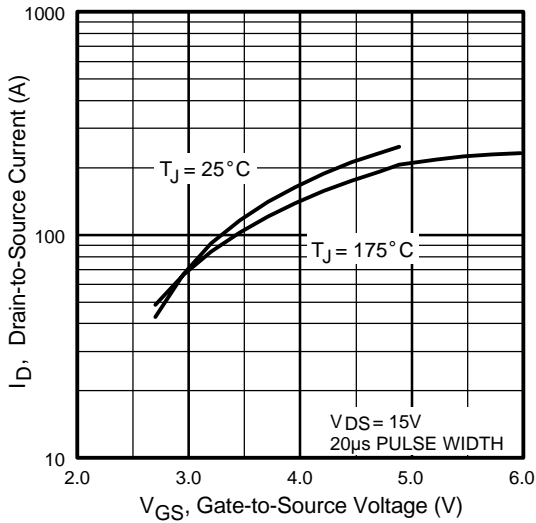

**Fig 3.** Typical Transfer Characteristics

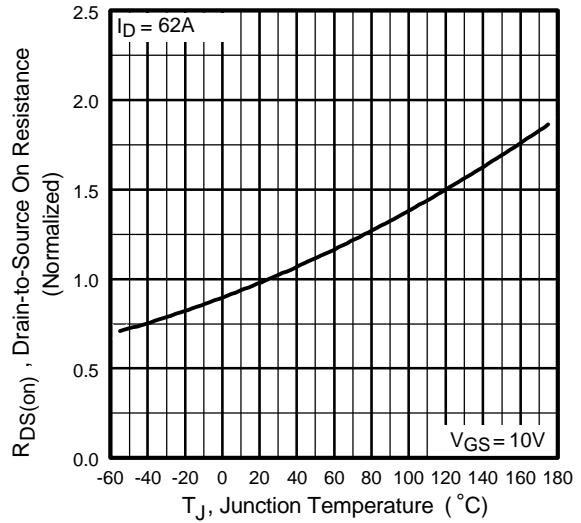

**Fig 4.** Normalized On-Resistance Vs. Temperature

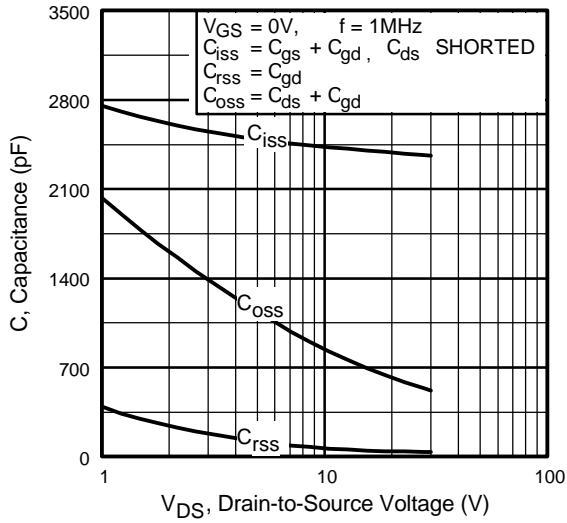

**Fig 5.** Typical Capacitance Vs. Drain-to-Source Voltage

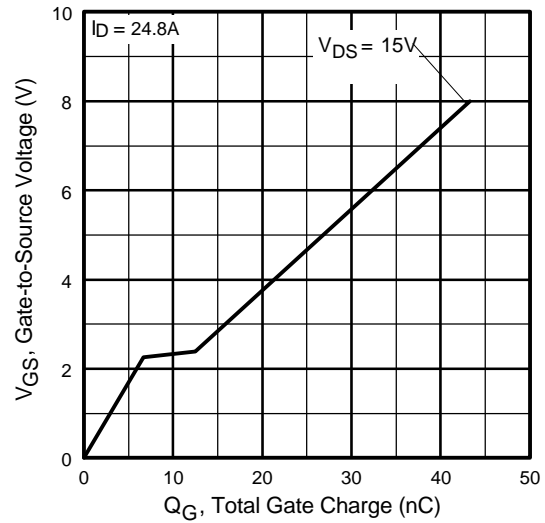

**Fig 6.** Typical Gate Charge Vs. Gate-to-Source Voltage

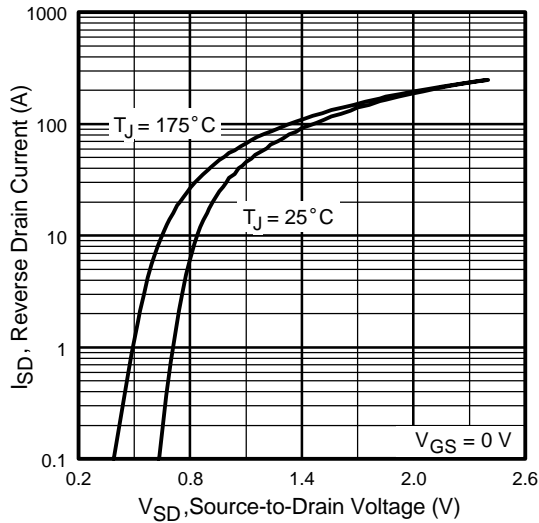

**Fig 7.** Typical Source-Drain Diode Forward Voltage

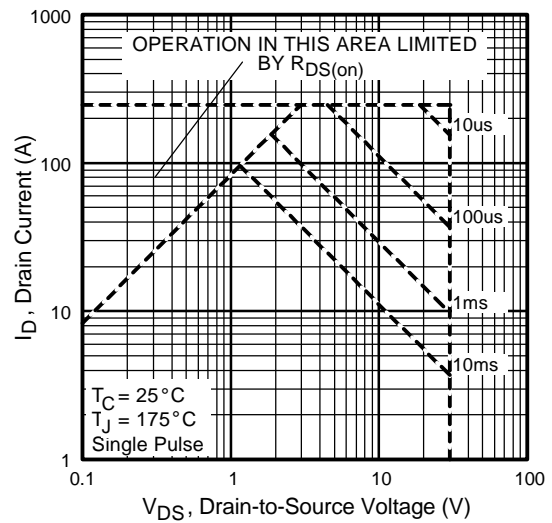

**Fig 8.** Maximum Safe Operating Area

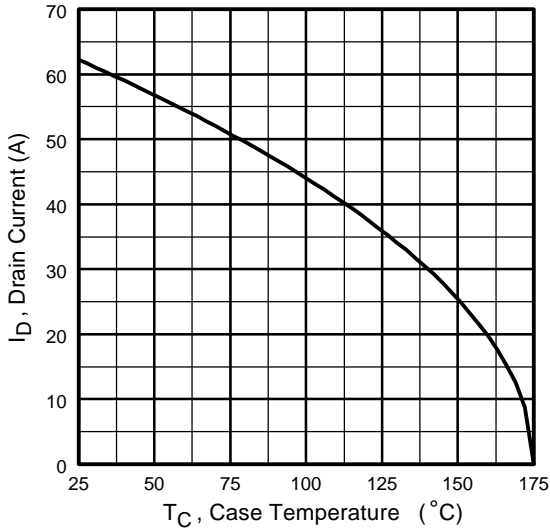

**Fig 9.** Maximum Drain Current Vs. Case Temperature

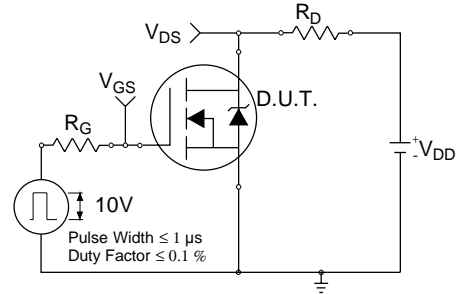

**Fig 10a.** Switching Time Test Circuit

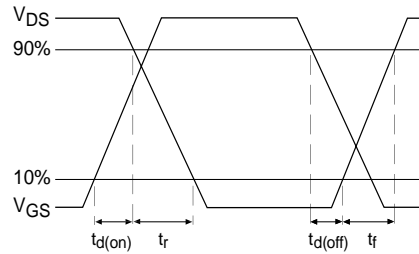

**Fig 10b.** Switching Time Waveforms

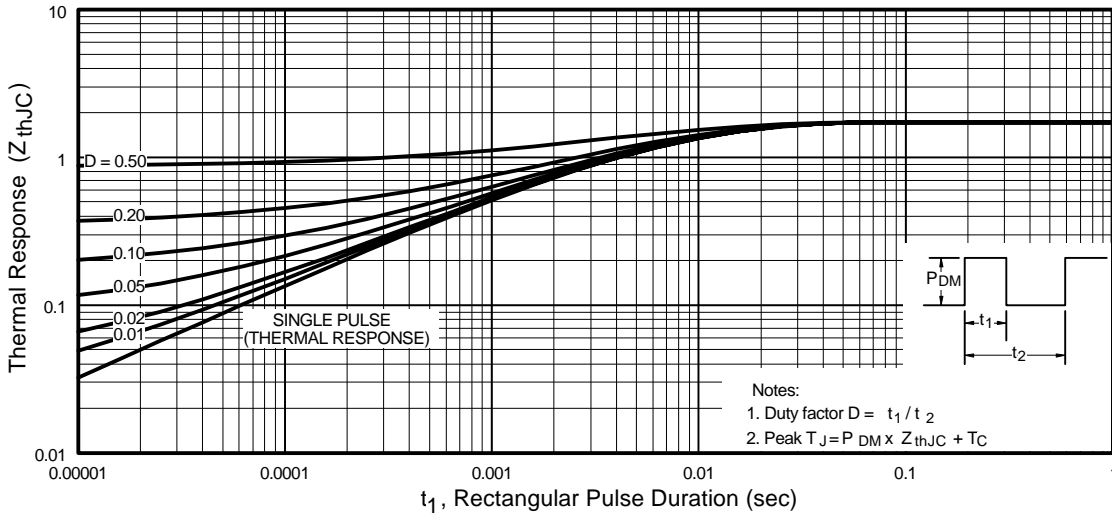

**Fig 11.** Maximum Effective Transient Thermal Impedance, Junction-to-Case

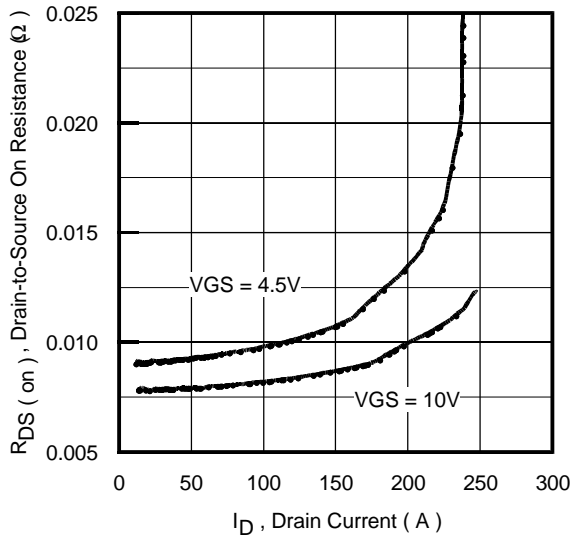

**Fig 12.** On-Resistance Vs. Drain Current

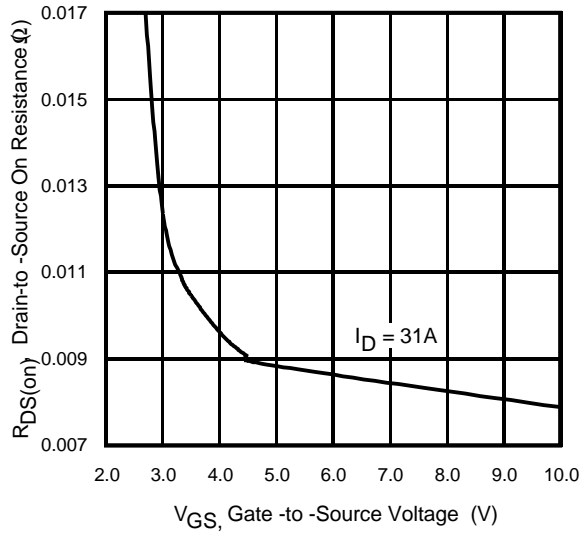

**Fig 13.** On-Resistance Vs. Gate Voltage

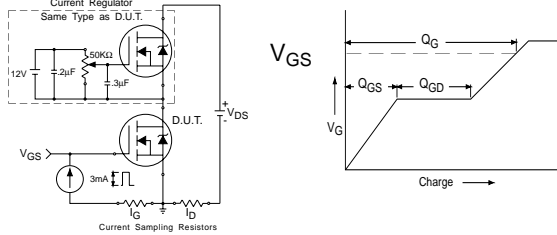

**Fig 14a&b.** Gate Charge Test Circuit and Waveform

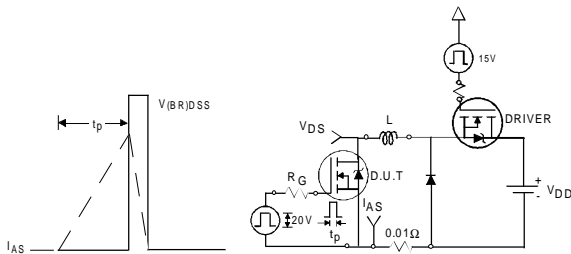

**Fig 15a&b.** Unclamped Inductive Test circuit and Waveforms

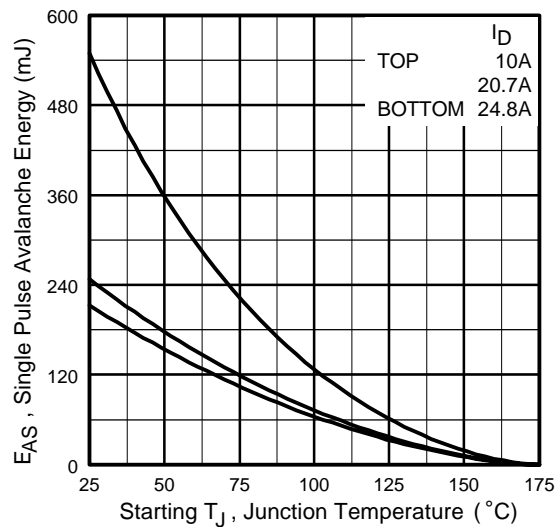

**Fig 15c.** Maximum Avalanche Energy Vs. Drain Current

## TO-220AB Package Outline

Dimensions are shown in millimeters (inches)

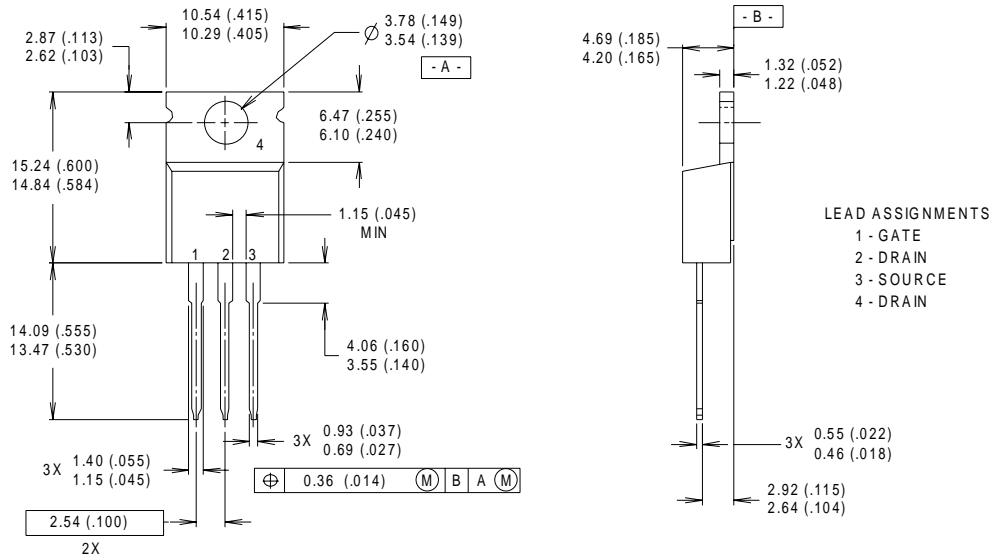

**NOTES:**

- 1 DIMENSIONING & TOLERANCING PER ANSI Y14.5M, 1982.
- 2 CONTROLLING DIMENSION : INCH
- 3 OUTLINE CONFORMS TO JEDEC OUTLINE TO-220AB.
- 4 HEATSINK & LEAD MEASUREMENTS DO NOT INCLUDE BURRS.

## TO-220AB Part Marking Information

EXAMPLE : THIS IS AN IRF1010  
 WITH ASSEMBLY  
 LOT CODE 9B1M



# IRF3708/3708S/3708L

International  
**IR** Rectifier

## D<sup>2</sup>Pak Package Outline

Dimensions are shown in millimeters (inches)

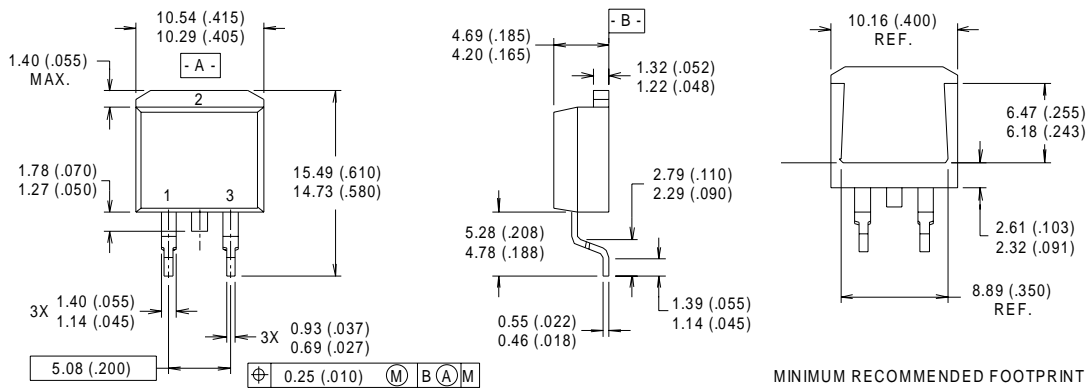

**NOTES:**

- 1 DIMENSIONS AFTER SOLDER DIP.
- 2 DIMENSIONING & TOLERANCING PER ANSI Y14.5M, 1982.
- 3 CONTROLLING DIMENSION : INCH.
- 4 HEATSINK & LEAD DIMENSIONS DO NOT INCLUDE BURRS.

**LEAD ASSIGNMENTS**

- 1 - GATE
- 2 - DRAIN
- 3 - SOURCE

**MINIMUM RECOMMENDED FOOTPRINT**

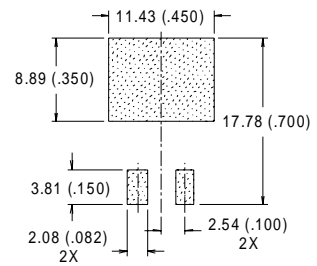

## D<sup>2</sup>Pak Part Marking Information

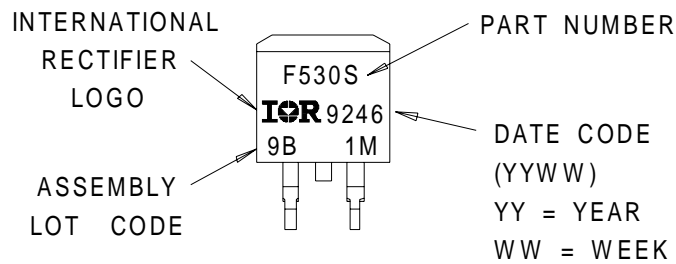



## TO-262 Package Outline

Dimensions are shown in millimeters (inches)

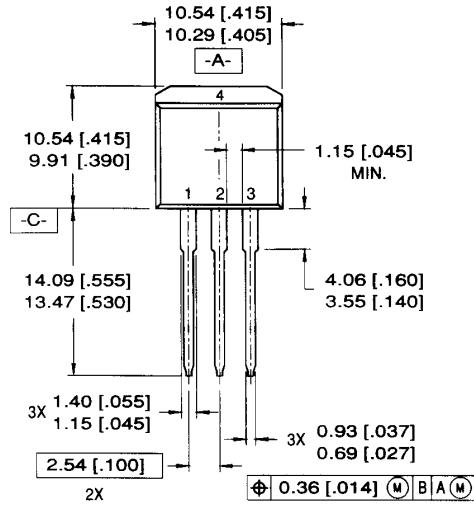

**LEAD ASSIGNMENTS**

1 = GATE	3 = SOURCE
2 = DRAIN	4 = DRAIN

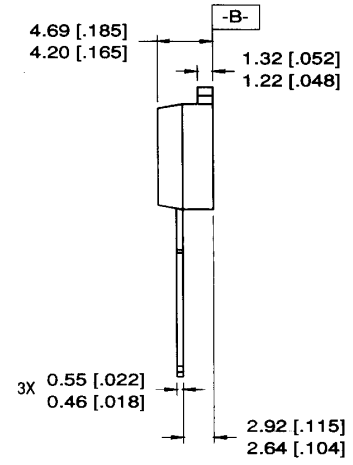

- NOTES:
1. DIMENSIONING & TOLERANCING PER ANSI Y14.5M-1982
  2. CONTROLLING DIMENSION: INCH.
  3. DIMENSIONS ARE SHOWN IN MILLIMETERS [INCHES].
  4. HEATSINK & LEAD DIMENSIONS DO NOT INCLUDE BURRS.

## TO-262 Part Marking Information

EXAMPLE: THIS IS AN IRL3103L  
 LOT CODE 1789  
 ASSEMBLED ON WW 19, 1997  
 IN THE ASSEMBLY LINE "C"

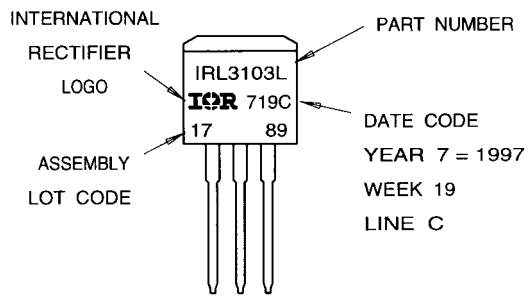

# IRF3708/3708S/3708L

International  
**IR** Rectifier

## D<sup>2</sup>Pak Tape & Reel Information

Dimensions are shown in millimeters (inches)

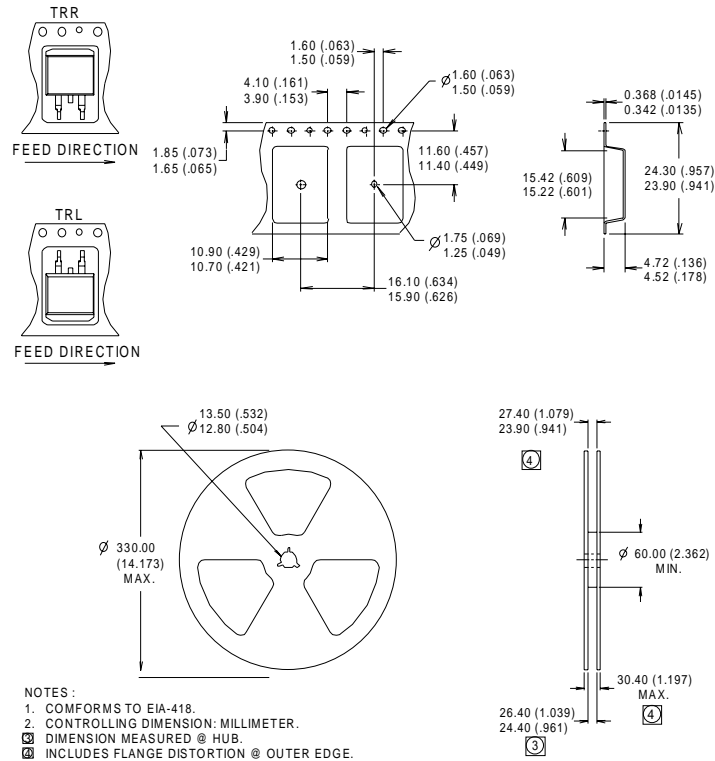

### Notes:

- ① Repetitive rating; pulse width limited by max. junction temperature.
- ② Starting  $T_J = 25^\circ\text{C}$ ,  $L = 0.7\text{ mH}$   
 $R_G = 25\Omega$ ,  $I_{AS} = 24.8\text{ A}$ .
- ③ Pulse width  $\leq 300\mu\text{s}$ ; duty cycle  $\leq 2\%$ .
- ④ This is only applied to TO-220AB package

International  
**IR** Rectifier

**IR WORLD HEADQUARTERS:** 233 Kansas St., El Segundo, California 90245, USA Tel: (310) 252-7105  
**IR EUROPEAN REGIONAL CENTRE:** 439/445 Godstone Rd, Whyteleafe, Surrey CR3 OBL, UK Tel: ++ 44 (0)20 8645 8000

**IR CANADA:** 15 Lincoln Court, Brampton, Ontario L6T3Z2, Tel: (905) 453 2200  
**IR GERMANY:** Saalburgstrasse 157, 61350 Bad Homburg Tel: ++ 49 (0) 6172 96590

**IR ITALY:** Via Liguria 49, 10071 Borgaro, Torino Tel: ++ 39 011 451 0111

**IR JAPAN:** K&H Bldg., 2F, 30-4 Nishi-Ikebukuro 3-Chome, Toshima-Ku, Tokyo 171 Tel: 81 (0)3 3983 0086

**IR SOUTHEAST ASIA:** 1 Kim Seng Promenade, Great World City West Tower, 13-11, Singapore 237994 Tel: ++ 65 (0)838 4630

**IR TAIWAN:** 16 Fl. Suite D. 207, Sec. 2, Tun Haw South Road, Taipei, 10673 Tel: 886-(0)2 2377 9936

*Data and specifications subject to change without notice. 8/00*